

Notes :

1. Category: Carriage Bolts
2. System of Measurement: Metric
3. Head Style: Round Head
4. Head Style Detail: Square Neck
5. Head Markings: Material Grade Mark "8.8"
6. Thread Length: Standard Thread Length
7. Thread Direction: Right-Hand Thread
8. Material: Steel
9. Material Grade: Class 8.8 Steel
10. Coating: Zinc Plated
11. Coating Color: Clear
12. Standards and Specifications: DIN 603 / ISO 8677

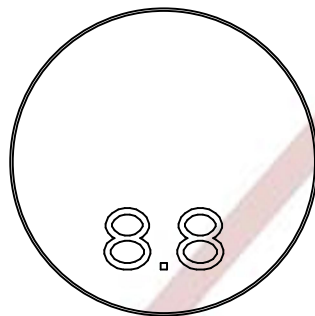

HEAD MARKING

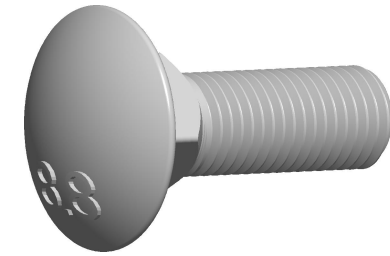
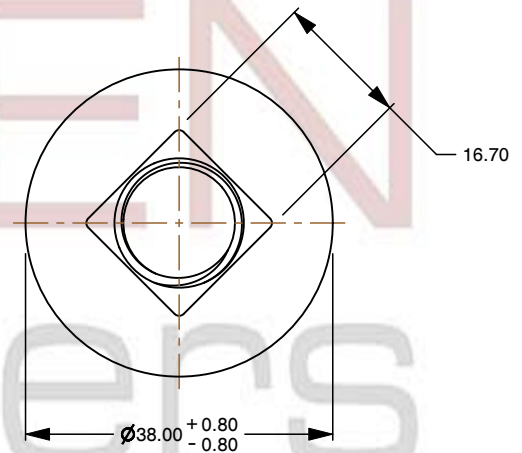
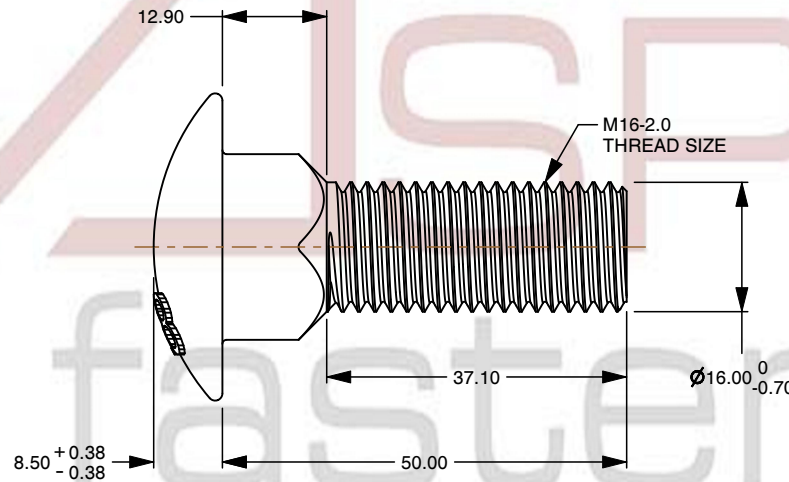

This file and any associated information and specifications are provided for reference and evaluation purposes only and is subject to change without notice. Aspen Fasteners Inc. makes no representations, warranties, or guarantees as to the appropriateness, accuracy, completeness, or suitability for any purpose of the file, information or specifications. You are solely responsible for the use of the file, information, or specifications.

This document is the property of Aspen Fasteners Inc. and the information it contains may not be reproduced, disclosed, or shared with any third party without the expressed written permission of Aspen Fasteners Inc.

SCALE 1.070

PRODUCT NAME
M16-2.0 X 50mm DIN 603 / ISO 8677,
Metric, Carriage Bolts, Round Head,
Square Neck, Class 8.8 Steel, Zinc Plated

PART NUMBER: ME079-1620X50

UNIT METRIC

ISSUED
2023-11-23

SHEET 1 of 1