

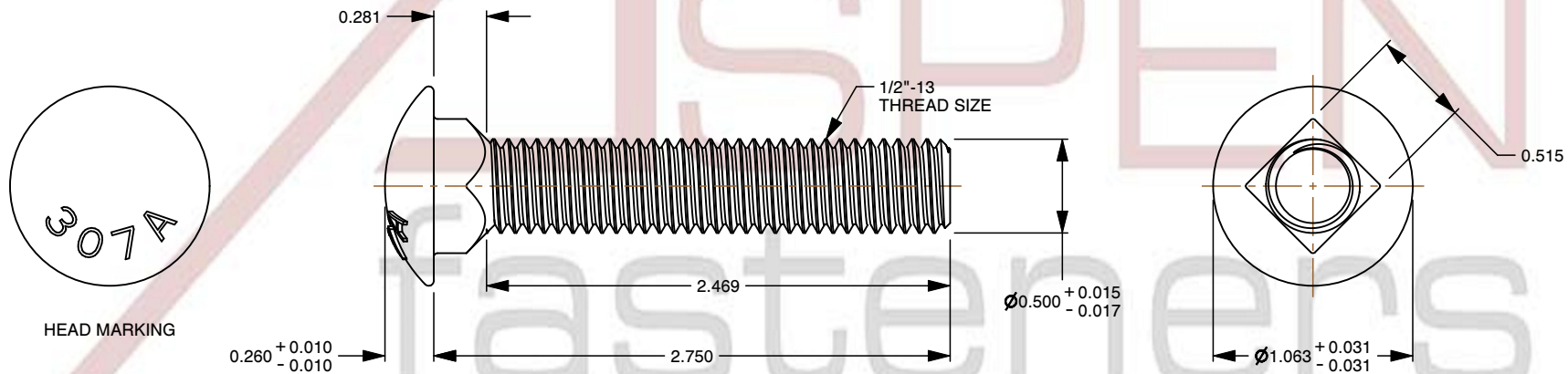

Notes :

1. Category: Carriage Bolts
2. System of Measurement: Inch
3. Head Style: Round Head
4. Head Style Detail: Square Neck
5. Head Markings: Material Grade Mark "A307"
6. Body Style: Undersized Body
7. Thread Length: Full Thread
8. Thread Direction: Right-Hand Thread
9. Material: Steel
10. Material Grade: A307 Steel
11. Coating: Uncoated
12. Standards and Specifications: ASME B18.5

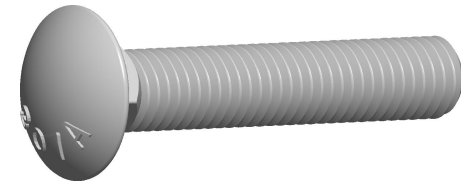

 www.aspenfasteners.com	This file and any associated information and specifications are provided for reference and evaluation purposes only and is subject to change without notice. Aspen Fasteners Inc. makes no representations, warranties, or guarantees as to the appropriateness, accuracy, completeness, or suitability for any purpose of the file, information or specifications. You are solely responsible for the use of the file, information, or specifications.	This document is the property of Aspen Fasteners Inc. and the information it contains may not be reproduced, disclosed, or shared with any third party without the expressed written permission of Aspen Fasteners Inc.	PRODUCT NAME 1/2"-13 X 2-3/4" Carriage Bolts, Round Head, Square Neck, Full Thread, A307 Steel, Plain	UNIT INCHES
			PART NUMBER: BO048-1213X234	ISSUED 2023-11-23
		SCALE 1.071	SHEET 1 of 1	