

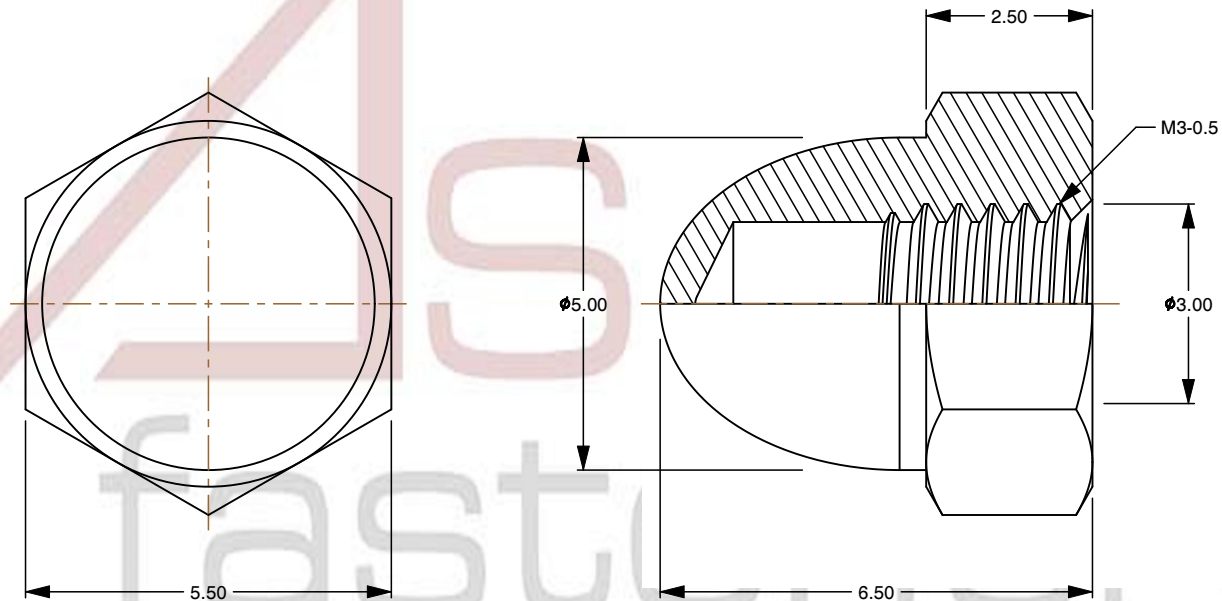

**Notes :**

1. Category: Acorn Cap Dome Nuts
2. System of Measurement: Metric
3. Form and Design: High Type
4. Drive Style: External Hex Drive
5. Thread Length: Full Thread
6. Thread Direction: Right-Hand Thread
7. Material: Stainless Steel
8. Material Grade: A4 Stainless Steel
9. Coating: Uncoated
10. Standards and Specifications: DIN 1587

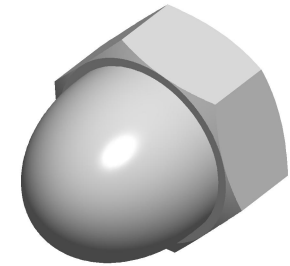

 <a href="http://www.aspenfasteners.com">www.aspenfasteners.com</a>	This file and any associated information and specifications are provided for reference and evaluation purposes only and is subject to change without notice. Aspen Fasteners Inc. makes no representations, warranties, or guarantees as to the appropriateness, accuracy, completeness, or suitability for any purpose of the file, information or specifications. You are solely responsible for the use of the file, information, or specifications.	This document is the property of Aspen Fasteners Inc. and the information it contains may not be reproduced, disclosed, or shared with any third party without the expressed written permission of Aspen Fasteners Inc.	PRODUCT NAME M3-0.5 DIN 1587, Metric, Acorn Cap Dome Nuts, A4 Stainless Steel	UNIT METRIC
			PART NUMBER: ME278-305X7X55	ISSUED 2023-11-23
		SCALE 8.799	SHEET 1 of 1	