

Notes :

1. Category: Hex Male-Female Standoffs
2. System of Measurement: Metric
3. Form and Design: 6mm Across Flats
4. Head Style: Headless
5. Drive Style: External Hex Drive
6. Thread Direction: Right-Hand Thread
7. Material: Aluminum
8. Material Grade: Standard Commercial Grade
9. Coating: Uncoated
10. Origin: Made in U.S.A.

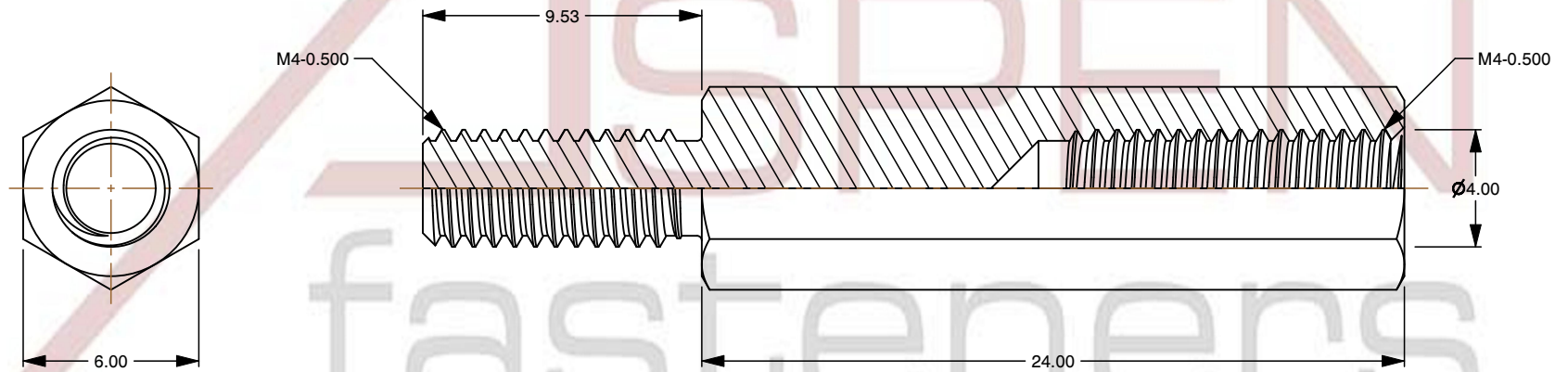
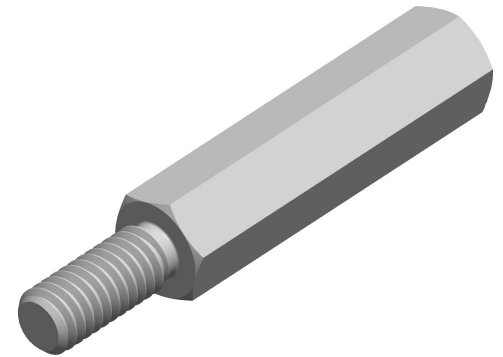

This file and any associated information and specifications are provided for reference and evaluation purposes only and is subject to change without notice. Aspen Fasteners Inc. makes no representations, warranties, or guarantees as to the appropriateness, accuracy, completeness, or suitability for any purpose of the file, information or specifications. You are solely responsible for the use of the file, information, or specifications.

This document is the property of Aspen Fasteners Inc. and the information it contains may not be reproduced, disclosed, or shared with any third party without the expressed written permission of Aspen Fasteners Inc.

SCALE 4.177

PRODUCT NAME
M4-0.7 X 24mm Hex Male-Female Standoffs,
Metric, 6mm Across Flats, Aluminum,
Made in U.S.A.

PART NUMBER: FC036-4070X24

UNIT
MILLIMETERS

ISSUED
2023-11-14

SHEET 1 of 1