

Notes :

1. Category: Captive Panel Screws
2. System of Measurement: Inch
3. Form and Design: Style 2
4. Head Style: Knurled High Head
5. Drive Style: Slotted Drive
6. Thread Direction: Right-Hand Thread
7. Mateial: Stainless Steel
8. Coating: Uncoated
9. Origin: Made in U.S.A.

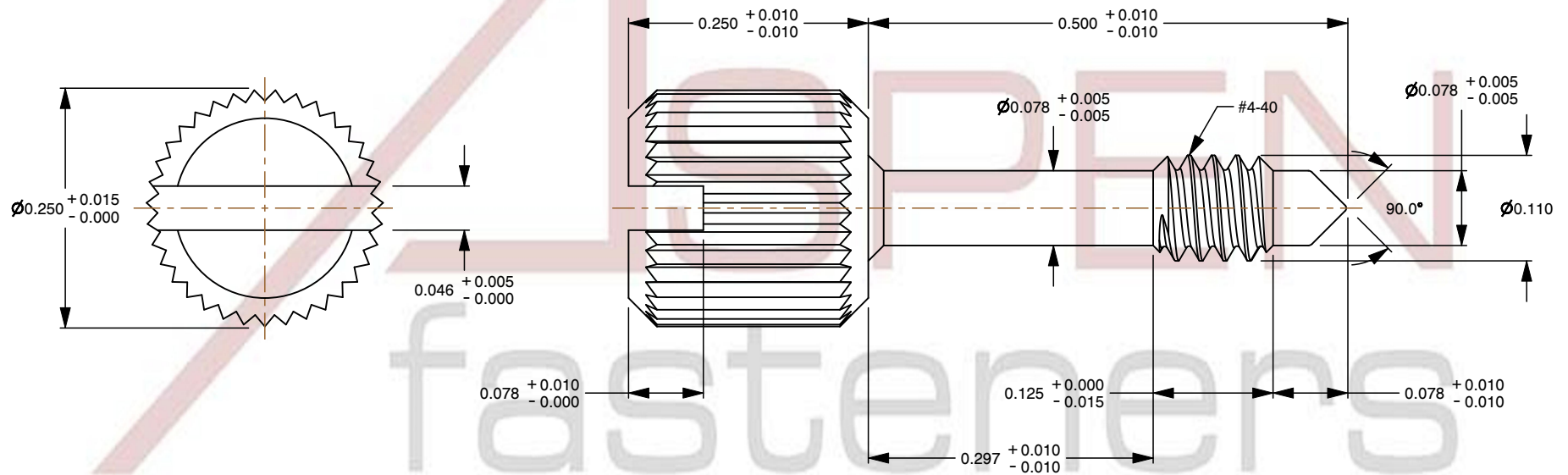
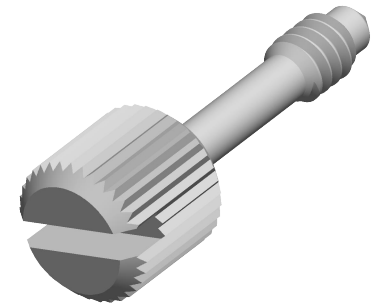

This file and any associated information and specifications are provided for reference and evaluation purposes only and is subject to change without notice. Aspen Fasteners Inc. makes no representations, warranties, or guarantees as to the appropriateness, accuracy, completeness, or suitability for any purpose of the file, information or specifications. You are solely responsible for the use of the file, information, or specifications.

This document is the property of Aspen Fasteners Inc. and the information it contains may not be reproduced, disclosed, or shared with any third party without the expressed written permission of Aspen Fasteners Inc.

PRODUCT NAME
#4-40 X 1/2", Head Dia = 1/4" Captive Panel Screws, Style 2, Knurled High Head, Slotted Drive, Stainless Steel, Made in U.S.A.

UNIT
INCHES

ISSUED
2023-11-14

SCALE 5.900

PART NUMBER: FC043-440X12X14

SHEET 1 of 1